

131

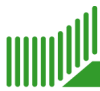

GLOBAL GARDEN PRODUCTS

1

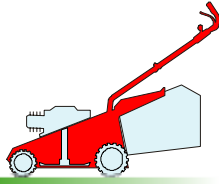

01D\_EP434TR

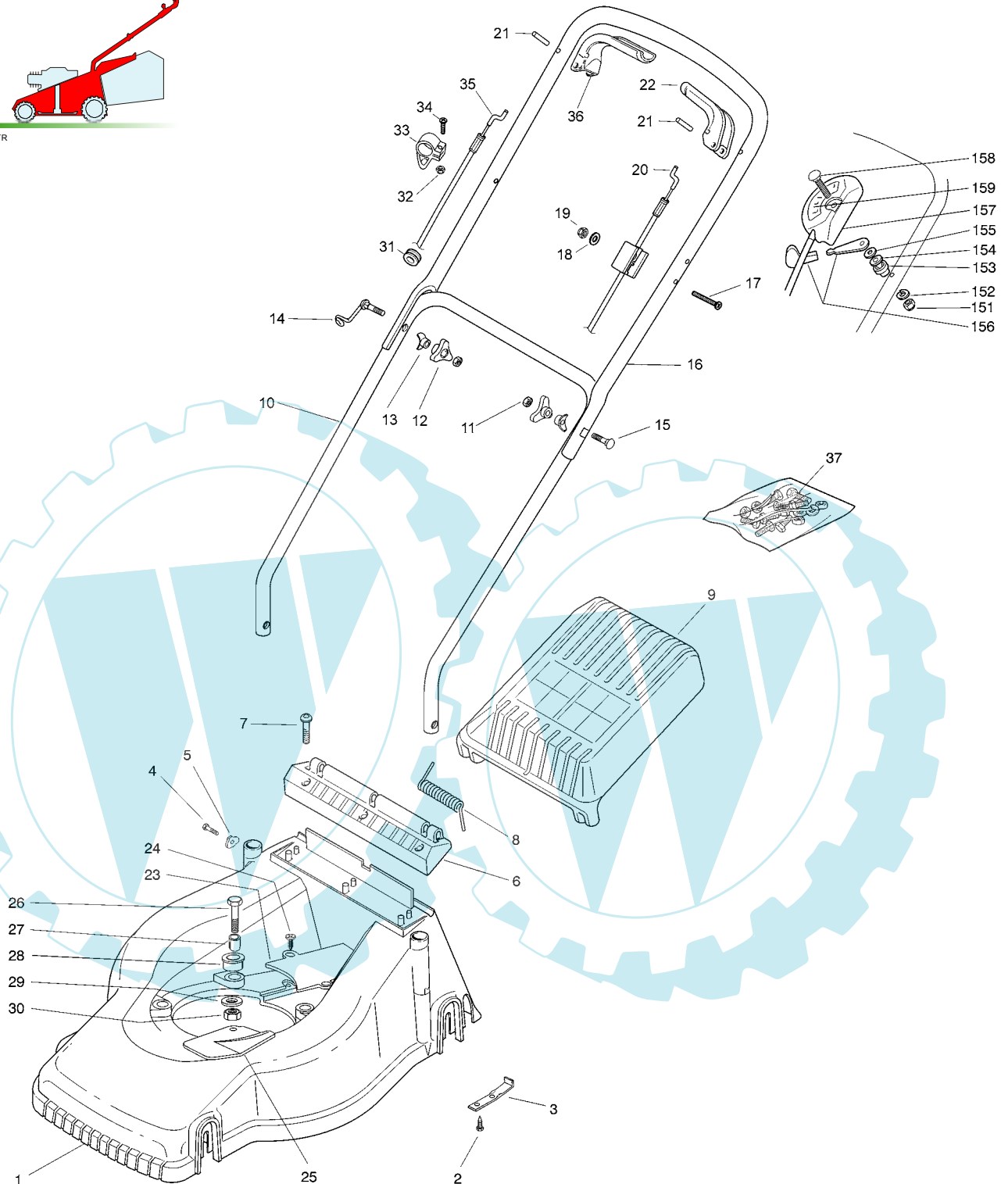

Pos.	Code	Q.ty	Descrizione	Description	Description	Beschreibung	Remarks
1	22066705/0	1	CHASSIS GIALLO	DECK YELLOW	CHÂSSIS JAUNE	GEHÄUSE GELB	
-	22066700/0	1	CHASSIS ROSSO	DECK RED	CHÂSSIS ROUGE	GEHÄUSE ROT	
-	22066709/0	1	CHASSIS VERDE	DECK GREEN	CHÂSSIS VERT	GEHÄUSE GRÜN	
2	12728680/0	4	VITE	SCREW	VIS	SCHRAUBE	
3	22608531/0	2	RINFORZO POSTERIORE	REAR STIFFENING	RÉNFORCEMENT ARRIERE	HINTERVERSTÄRKUNG	
4	12728099/1	2	VITE	SCREW	VIS	SCHRAUBE	
5	22545135/0	2	PIASTRINA	PLATE	PLAQUETTE	PLÄTTCHEN	
6	22785165/0	1	SUPPORTO	SUPPORT	SUPPORT	HALTER	

## GLOBAL GARDEN PRODUCTS

Pos.	Code	Q.ty	Descrizione	Description	Description	Beshreibung	Remarks
7	12728686/0	3	VITE	SCREW	VIS	SCHRAUBE	
8	22450430/0	1	MOLLA	SPRING	RESSORT	FEDER	
9	22600079/0	1	PARASASSI	STONE-GUARD	PARE-PIERRES	PRALLBLECH	
10	81006609/0	1	MANICO INFERIORE	HANDLE, LOWER PART	MANCHERON INFERIEURE	HOLM, UNTERTEIL	
11	12293200/0	2	DADO	NUT	ECROU	MUTTER	
12	22399900/0	2	MANOPOLINA	KNOB	POIGNÉE	GRIFF	
13	22680006/1	2	ROSETTA	WASHER	RONDELLE	SCHEIBE	
14	81003801/1	1	MOLLA GUIDA	GUIDE SPRING	RESSORT DE GUIDE	FEDER FÜHRER	
15	12819201/0	1	VITE	SCREW	VIS	SCHRAUBE	
16	81006577/0	1	MANICO SUPERIORE	HANDLE, UPPER PART	MANCHERON SUPERIEURE	HOLM, OBERTEIL	
17	12674700/0	1	VITE	SCREW	VIS	SCHRAUBE	
18	12521330/0	1	ROSETTA	WASHER	RONDELLE	SCHEIBE	
19	12292100/0	1	DADO	NUT	ECROU	MUTTER	
20	81000613/0	1	CAVO FRENO MOTORE	CABLE, THREAD MOTOR BRAKE	CABLE FREIN MOTEUR	KABEL, MOTORBREMSE	(B&S)
-	81000614/0	1	CAVO FRENO MOTORE	CABLE, THREAD MOTOR BRAKE	CABLE FREIN MOTEUR	KABEL, MOTORBREMSE	(SUMEC)
21	12645710/0	2	SPINA	PIN	GOUILLE	STIFT	
22	22321700/0	1	LEVA FRENO MOTORE	LEVER, MOTOR BRAKE	LEVIER FREIN MOTEUR	HEBEL, MOTORBREMSE	
23	22060171/0	1	CARTER CINGHIA	PROTECTION, BELT	PROTECTION COURROIRE	SCHUTZ, RIEMEN	
24	12728686/0	2	VITE	SCREW	VIS	SCHRAUBE	
25	22484070/1	1	PARACALORE	MUFFLER GUARD	GRILLE DE PROTECTION	SCHUTZABDECKUNG	
26	12691900/0	3	VITE	SCREW	VIS	SCHRAUBE	
27	22167842/0	3	DISTANZIALE	SPACER	ENTRETOISE	DISTANZRING	
28	22040265/0	1	BUSSOLA	BUSH	DOUILLE	BUCHSE	
29	12523070/0	3	ROSETTA	WASHER	RONDELLE	SCHEIBE	
30	12155000/0	3	DADO	NUT	ECROU	MUTTER	
31	18564520/1	1	PASSACAVO	FAIR LEAD	PASSE CABLE	KABELDURCHGANG	
32	12292100/0	1	DADO	NUT	ECROU	MUTTER	
33	22806521/0	1	FASCETTA	CLAMP	COLLIER	BOWDENZUGHALTER	
34	12769616/0	1	VITE	SCREW	VIS	SCHRAUBE	
35	81000704/0	1	CAVO COMANDO TRAZIONE	CABLE, REAR DRIVE	CÂBLE, COMMANDE TRACTION	KABEL, ANTRIEB	
36	22321701/0	1	LEVA TRAZIONE	DRIVING LEVER	LEVIER TRACTION	ANTRIEBHEBEL	
37	--	1	DOTAZIONE VITERIA	OUTFIT, SCREWS	DOTATION VISSERIE	SATZ, SCHRAUBEN	

## VARIANTE ACCELERATORE - THROTTLE MODIFICATION - MODIFICATION COMMANDE D'ACCELERATION - ÄNDERUNGEN AUF GASHEBEL

Pos.	Code	Q.ty	Descrizione	Description	Description	Beshreibung	Remarks
151	12291000/0	1	DADO	NUT	ECROU	MUTTER	
152	12581500/0	1	GROWER	GROWER	GROWER	FEDERRING	
153	22171005/0	1	DISTANZIALE	SPACER	ENTRETOISE	DISTANZRING	
154	12521360/0	1	ROSETTA	WASHER	RONDELLE	SCHEIBE	
155	12508100/0	1	ROSETTA ELASTICA	SPRING WASHER	RONDELLE ELASTIQUE	ELASTISCHE SCHEIBE	
156	81007279/1	1	LEVA, ACCELERATORE	LEVER, THROTTLE	LEVIER, ACCELERATEUR	HEBEL, BESHLEUNIGER	
157	81007093/0	1	CAVO ACCELERATORE	CABLE, TROTTLE	CABLE, ACCELERATEUR	KABLE, BESCHLEUNIGER	
158	12815000/0	1	VITE	SCREW	VIS	SCHRAUBE	
159	14356703/0	1	ETICHETTA	LABEL	ETIQUETTE	ETIKETTE	(B&S)
-	14360197/0	1	ETICHETTA	LABEL	ETIQUETTE	ETIKETTE	(SUMEC)

131

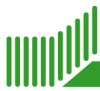

GLOBAL GARDEN PRODUCTS

2

02D\_059A

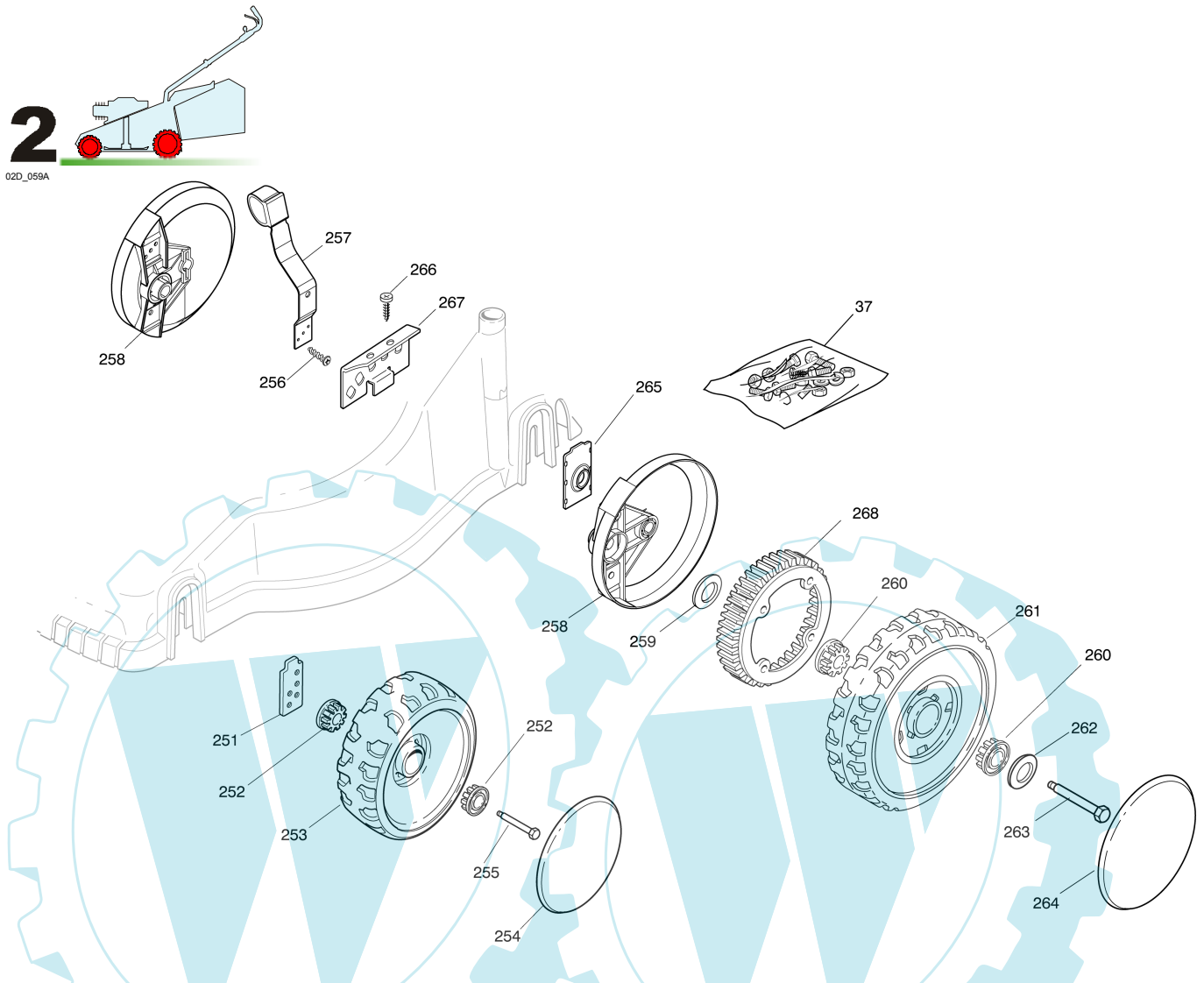

Pos.	Code	Q.ty	Descrizione	Description	Description	Beshreibung	Remarks
37	81008673/1	1	DOTAZIONE VITERIA	OUTFIT, SCREWS	DOTATION VISSERIE	SATZ, SCHRAUBEN	
251	22785093/0	2	SUPPORTO RUOTA	SUPPORT, WHEEL	SUPPORT ROUE	HALTER, RAD	
252	22034515/1	4	BUSSOLA	BUSH	DOUILLE	BUCHSE	
253	22686091/1	2	RUOTA Ø 165	WHEEL Ø 165	ROUE Ø 165	RAD Ø 165	
254	22110262/0	2	COPRIMOZZO BIANCO	HUB CAP WHITE	COUVRE-MOYEU BLANC	RADKAPPE WEIßE	
255	22524340/0	2	PERNO	PIN	PIVOT	BOLZEN	
256	12728689/0	2	VITE	SCREW	VIS	SCHRAUBE	
257	81003303/0	1	LEVA REGOLAZIONE ALTEZZA	LEVER, HEIGHT ADJUSTMENT	LEVIER REGLAGE HAUTEUR	HEBEL, HÖNEVERSTELLUNG	
258	22600106/1	2	PROT. RUOTE	PROTECTION, WHEEL	PROTECTION ROUE	SCHÜTZ, RÄDER	
259	12521370/0	2	ROSETTA	WASHER	RONDELLE	SCHEIBE	
260	22034508/0	4	BUSSOLA	BUSH	DOUILLE	BUCHSE	
261	22686093/0	2	RUOTA Ø 190	WHEEL Ø 190	ROUE Ø190	RAD Ø 190	
262	12523050/0	2	ROSETTA	WASHER	RONDELLE	SCHEIBE	
263	12735599/0	2	VITE	SCREW	VIS	SCHRAUBE	
264	22110265/0	2	COPRIMOZZO BIANCO	HUB CAP WHITE	COUVRE-MOYEU BLANC	RADKAPPE WEIßE	
265	22557149/0	2	PIASTRINA	PLATE	PLAQUETTE	PLÄTTCHEN	
266	12728680/0	2	VITE	SCREW	VIS	SCHRAUBE	
267	22735567/0	1	SETTORE DI REGOLAZIONE	SECTOR, HEIGHT ADJUSTMENT	SECTEUR REGLAGE	SEKTOR, HÖNEVERSTELLUNG	
268	22120109/0	2	RUOTA DENTATA	SPROCKET	COURONNE	ZAHNKETTENRA	

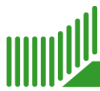

GLOBAL GARDEN PRODUCTS

2

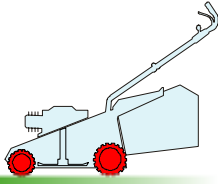

02D\_059B

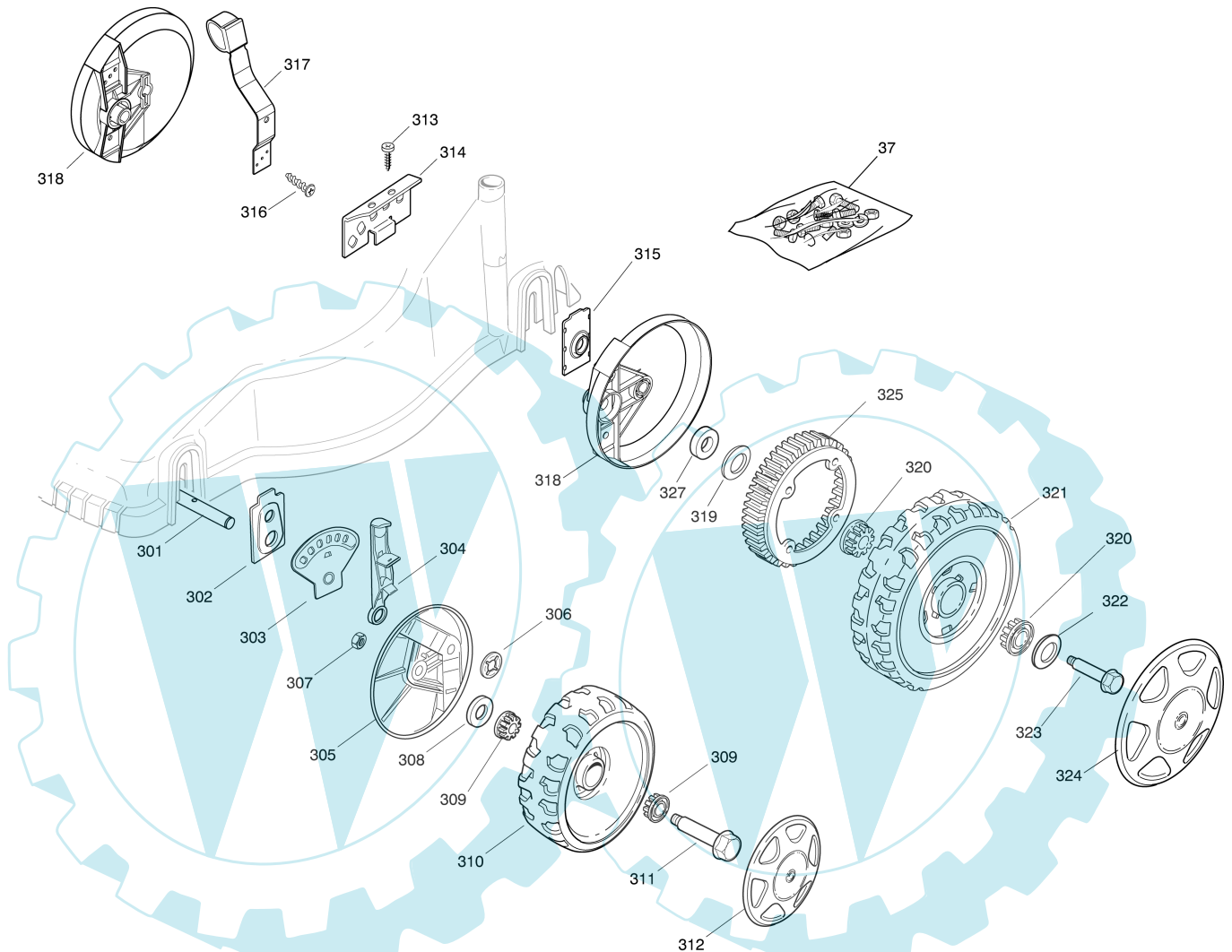

VARIANTE REGOLAZIONE RUOTE - WHEEL ADJUSTMENT MODIFICATION - MODIFICATION REGLAGE ROUES - ÄNDERUNG RADEINSTELL

Pos.	Code	Q.ty	Descrizione	Description	Description	Beshreibung	Remarks
37	81008661/1	1	DOTAZIONE VITERIA	OUTFIT, SCREWS	DOTATION VISSERIE	SATZ, SCHRAUBEN	
301	22033363/0	1	ASSE	AXLE	AXE	ACHSE	
302	22785135/0	2	SUPPORTO	SUPPORT	SUPPORT	HALTER	
303	22735555/0	2	SETTORE DI REGOLAZIONE	SECTOR, HEIGHT ADJUSTMENT	SECTEUR REGLAGE	SEKTOR, HÖHEVERSTELLUNG	
304	81003306/0	2	LEVA REGOLAZIONE ALTEZZA	LEVER, HEIGHT ADJUSTMENT	LEVIER REGLAGE HAUTEUR	HEBEL, HÖNEVERSTELLUNG	
305	22600096/0	2	PROT. RUOTE	PROTECTION, WHEEL	PROTECTION ROUE	SCHÜTZ, RÄDER	
306	22020050/0	2	ANELLO ELASTICO	SNAP RING	ANNEAU RESSORT	SPRENGRING	
307	12155000/0	2	DADO	NUT	ECROU	MUTTER	
308	25670011/0	2	ROSETTA	WASHER	RONDELLE	SCHEIBE	
309	22034508/0	4	BUSSOLA	BUSH	DOUILLE	BUCHSE	
310	22686091/1	2	RUOTA Ø 165	WHEEL Ø 165	ROUE Ø 165	RAD Ø 165	
311	22524341/0	2	PERNO	PIN	PIVOT	BOLZEN	
312	22110344/0	2	COPRIMOZZO BIANCO	HUB CAP WHITE	COUVRE-MOYEU BLANC	RADKAPPE WEIßE	
313	12728680/0	2	VITE	SCREW	VIS	SCHRAUBE	
314	22735567/0	1	SETTORE DI REGOLAZIONE	SECTOR, HEIGHT ADJUSTMENT	SECTEUR REGLAGE	SEKTOR, HÖHEVERSTELLUNG	



131

## GLOBAL GARDEN PRODUCTS

Pos.	Code	Q.ty	Descrizione	Description	Description	Beschreibung	Remarks
315	22557149/0	2	PIASTRINA	PLATE	PLAQUETTE	PLÄTTCHEN	
316	12728689/0	2	VITE	SCREW	VIS	SCHRAUBE	
317	81003303/0	1	LEVA REGOLAZIONE ALTEZZA	LEVER, HEIGHT ADJUSTMENT	LEVIER REGLAGE HAUTEUR	HEBEL, HÖNEVERSTELLUNG	
318	22600106/1	2	PROT. RUOTE	PROTECTION, WHEEL	PROTECTION ROUE	SCHÜTZ, RÄDER	
319	12521370/0	2	ROSETTA	WASHER	RONDELLE	SCHEIBE	
320	22034508/0	4	BUSSOLA	BUSH	DOUILLE	BUCHSE	
321	22686093/0	2	RUOTA Ø 190	WHEEL Ø 190	ROUE Ø190	RAD Ø 190	
322	12523050/0	2	ROSETTA	WASHER	RONDELLE	SCHEIBE	
323	12735599/0	2	VITE	SCREW	VIS	SCHRAUBE	
324	22110313/0	2	COPRIMOZZO BIANCO	HUB CAP WHITE	COUVRE-MOYEU BLANC	RADKAPPE WEIßE	
325	22120109/0	2	RUOTA DENTATA	SPROCKET	COURONNE	ZAHNKETTENRA	
327	22170622/0	2	DISTANZIALE	SPACER	ENTRETOISE	DISTANZRING	

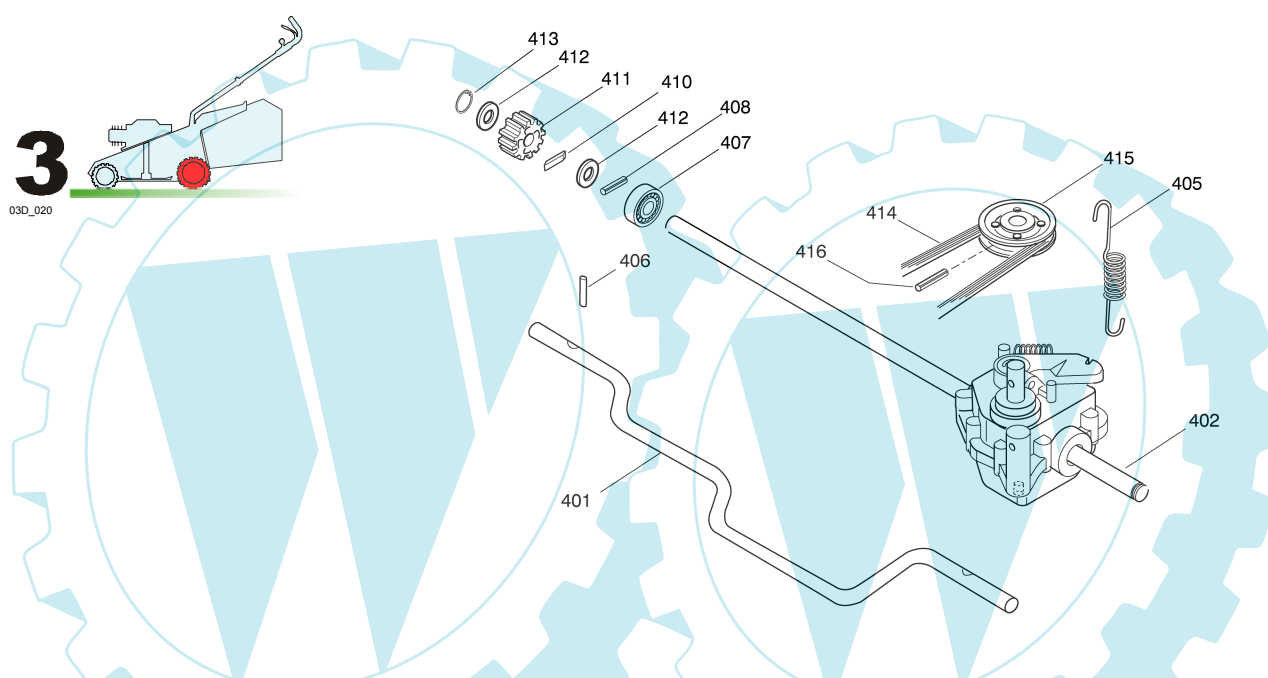

Pos.	Code	Q.ty	Descrizione	Description	Description	Beschreibung	Remarks
401	22033393/0	1	ASSE RUOTE POSTERIORE	AXLE, REAR WHEELS	AXE ROUES ARRIERE	ACHSE, HINTERRAD	
402	81003093/0	1	ASSE RUOTE POSTERIORE	AXLE, REAR WHEELS	AXE ROUES ARRIERE	ACHSE, HINTERRAD	
405	22430216/0	1	MOLLA	SPRING	RESSORT	FEDER	
406	22753001/0	2	SPINA	PIN	GOUPILLE	STIFT	
407	22122200/0	2	CUSCINETTO	BEARING	COUSSINET	LAGER	
408	12622620/0	2	SPINA	PIN	GOUPILLE	STIFT	
410	22076645/0	2	CHIAVE	KEY	CLEF	SCHLÜSSEL	
411	22570125/0	2	PIGNONE	PINION	PIGNON	RITZEL	
412	22160520/0	4	DISCO PARAPOLVERE	DUST COVER	PROTEGE-POUSSIERE	STAUBSCHUTTSCHIBE	
413	12608520/0	2	SEEGER	SEEGER	SEEGER	SEEGER	
414	35063800/0	1	CINGHIA Z 27	BELT Z 27	COURROIE Z 27	RIEMEN Z 27	
415	22601904/0	1	PULEGGIA	PULLEY	POULIE	RIEMENSCHIBE	
416	12645705/0	1	SPINA	PIN	GOUPILLE	STIFT	

131

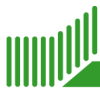

GLOBAL GARDEN PRODUCTS

5

05D\_003

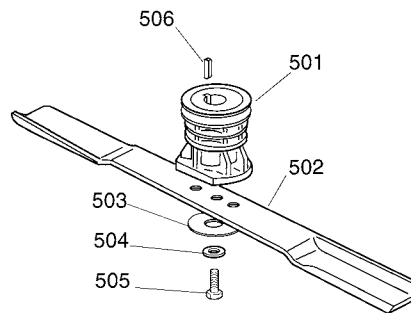
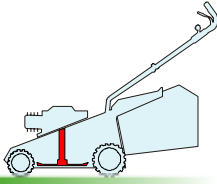

Pos.	Code	Q.ty	Descrizione	Description	Description	Beschreibung	Remarks
501	22465607/0	1	MOZZO CON PULEGGIA	HUB WITH PULLEY	MOYEU AVEC POULIE	NABE MIT SCHEIBE	
502	81004341/3	1	COLTELLO STANDARD	BLADE STANDARD	LAME STANDARD	MESSER STANDARD	
503	22160400/0	1	DISCO ELASTICO	ELASTIC WASHER	DISQUE ELASTIQUE	FEDERSCHEIBE	
504	12523080/0	1	ROSETTA	WASHER	RONDELLE	SCHEIBE	
505	12735698/0	1	VITE	SCREW	VIS	SCHRAUBE	
506	12139100/0	1	LINGUETTA	FEATHER	CLAVETTE	KEIL	

6

06D\_018

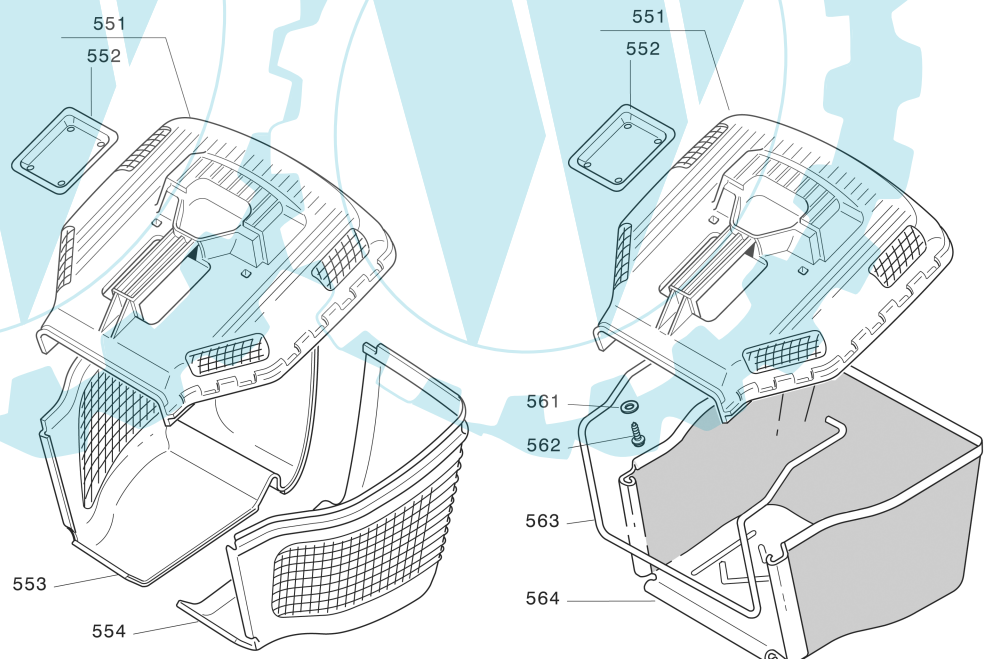
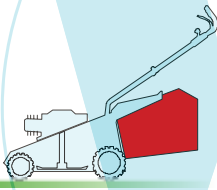

Pos.	Code	Q.ty	Descrizione	Description	Description	Beschreibung	Remarks
551	22486115/0	1	PARTE SUP.SACCO	GRASSBOX UPPER PART	SAC, PARTIE SUPERIEURE	KORB OBERTEIL	
552	22486098/0	1	PIASTRINA	PLATE	PLAQUETTE	PLÄTTCHEN	
553	22486120/0	1	PARTE INFER. SACCO DX	GRASSBOX LOWER PART (R)	SAC, PARTIE INFERIEURE (D)	KORB UNTERTEIL (R)	
554	22486119/0	1	PARTE INFER. SACCO SX	GRASSBOX LOWER PART (L)	SAC, PARTIE INFERIEURE (G)	KORB UNTERTEIL (L)	
561	12521460/0	2	ROSETTA	WASHER	RONDELLE	SCHEIBE	
562	12728300/0	2	VITE	SCREW	VIS	SCHRAUBE	
563	22608528/0	1	RINFORZO INF	STIFFENING LOWER	RÉNFORCEMENT INF	VERSTÄRKUNG UNTERE	
564	81002235/0	1	SACCO, TELA	BOX, FABRIC	SAC, TOILE	SACK, TUCK	